



niveetaTM
CORPORATION
FURNITURE | INTERIORS | PODS



Design as per Indian Weather Conditions

"Step into productivity with our cozy office pods!"



MADE
IN
INDIA

PRODUCT CATALOGUE

2025-26

Don't buy a Wooden Box



Buy a Perfect Pod

Get our International Featured Office Pods, Calling Booths, the perfect solution for creating private workspaces in any office setting.

- MODULAR DESIGNS
- PERFECT SOUND PROOF
- MOVABLE
- PLUG & PLAY



Phone Booths
Calling Booths
Telephone Booths
Meeting Pods
Office Pods



Ultra



Zawa



Jimmy

TECHNICAL INFORMATION

AVAILABLE MODELS	Ultra, Zawa and Jimmy		
AVAILABLE SIZES	1 User Calling Pods	Working / 2 User Pods	Meeting Pods
	1000x1000x2000mm	1200x1500x2100mm	1500x2100x2000mm
	1050x1050x2000mm	1500x1500x2000mm	1800x2100x2000mm
	1200x1200x2000mm	1000x1800x2000mm	1800x2400x2000mm
		1200x2100x2000mm	
CAPACITY	1 Seater to 8 Seater		
INTERNAL STRUCTURE	CRCA Metal Strong Structure Powder Coated		
INTERNAL SURFACE	<ul style="list-style-type: none"> • 2 or 3 Side Acoustic PET Panel/ Fabric • 1 or 2 Side Fix Glass/ One Glass Door with Spring Loaded Hinges • Glass wool insulation inside wall 		
OUTER SURFACE (Ultra Model)	Powder Coated 1.2 mm Galvanized Metal Sheet		
OUTER SURFACE (Zawa Model)	Powder Coated 1.2 mm Galvanized Metal Sheet or same with Fabric		
OUTER SURFACE (Jimmy Model)	Powder Coated 1.2 mm Galvanized Metal Sheet/ Laminate/ Fabric		
AIR FLOW	Fully automated ventilation controlled by occupancy sensor. Can be set to 1 hour and is adjustable up to 15 minutes. Optional Air Purifying System with HEPA Filter		
AUTOMATED LIGHTS	Fully automated lights controlled by occupancy sensor. As standard, set to 1 Minute and is adjustable up to 15 minutes. <ul style="list-style-type: none"> • Additional Socket for Fan. • 2 x LED light set on the ceiling. 		
WORKTOP	Foldable Prelam WorkTop Pneumatic Height Adjustable WorkTop (Optional)		
WHEELS	Lockable wheels with floor leveller.		
CONNECTIVITY	2 x power sockets • 1 x data or 1 x Voice outlet (Optional) • Type C Charger • USS Port		
POWER CONNECTION	From the ceiling, side or floor (as per the site requirement)		
CUP HOLDER	Foldable Cup Holder		
DOOR	- Stile Door with Spring Loaded Hinges - Full Glass Door		
NOISE REDUCTION	Speech level reduction up to 35 DB as per TUV-ISO23351+Certificate		

Ultra Series

MATERIAL DESCRIPTION

EXTERIOR	Metal Powder Coated Frame with Powder Coated 1.2 mm Galvanized Metal Sheet
INTERIOR	Acoustic PET panel on the ceiling. 2 Side Wall Acoustic panel and 2 Side Glass carpeted Floor.
DOOR	Stile Door with Glass side panels, stainless steel Door handle with Spring loaded Hinges. 12mm Glass Door, stainless steel Door handle.

ADD-ON FEATURES

POD PANEL

PET PANEL is an acoustic-friendly add-on piece for POD. It can be used as a surface to attach notes, plans, and other sketches. Panels attaches easily to the POD exterior and softens the surrounding sound environment.



Exterior Metal Colour Options



Interior Acoustic Colour Options

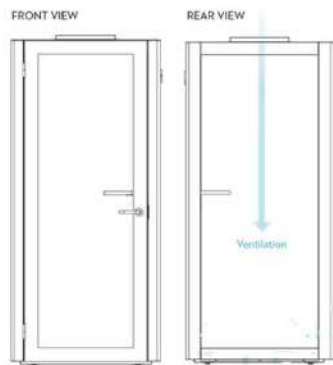

Zawa Series

MATERIAL DESCRIPTION

- EXTERIOR** Metal Powder Coated Frame with Powder Coated 1.2 mm Galvanized Metal Sheet/ Fabric Finish
- INTERIOR** Acoustic PET panel on the ceiling.
2 Side Wall Acoustic panel and 2 Side Glass
Carpeted Floor.
- DOOR** Stile Door with Glass side panels, stainless steel Door handle with Spring Loaded Hinges.

12mm Glass Door, stainless steel Door handle.

ADD-ON FEATURES

POD PANEL

POD PANEL is an acoustic-friendly add-on piece for POD rooms. It can be used as a surface to attach notes, plans, and other sketches. Panels attaches easily to the POD exterior and softens the surrounding sound environment.



Exterior Metal Colour Options



Optional Exterior Fabric Colour Options



Interior Acoustic Colour Options

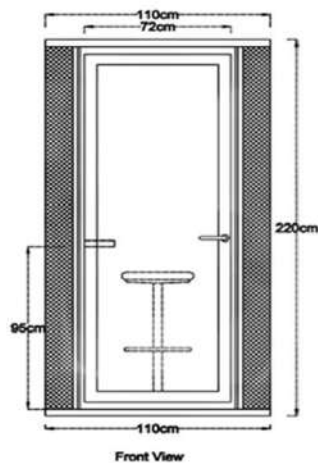
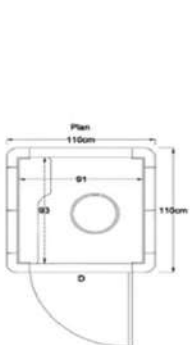

Front View

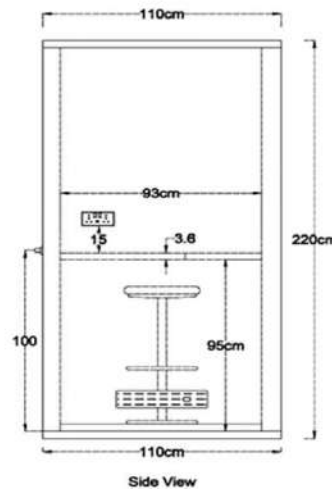

Side View



Jimmy Series

MATERIAL DESCRIPTION

EXTERIOR	Metal Powder Coated Frame with Powder Coated 1.2 mm Galvanized Metal Sheet/ Fabric Finish/ Wood Finish
INTERIOR	Fabric or Acoustic panel on the ceiling. 2 Side/ 3 Side Wall Acoustic panel and 1/ 2 Side Glass Carpeted floor.
DOOR	Stile Door with Glass side panels, stainless steel Door handle with Spring Loaded Hinges. 12mm Glass Door, stainless steel Door handle.

ADD-ON FEATURES

POD PANEL

POD PANEL is an acoustic-friendly add-on piece for POD rooms. It can be used as a surface to attach notes, plans, and other sketches. Panels attaches easily to the POD exterior and softens the surrounding sound environment.



Exterior Fabric Colour Options



Exterior Metal Colour Options



Interior Acoustic Colour Options

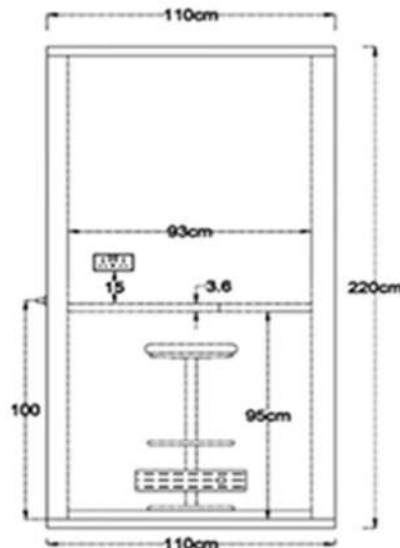
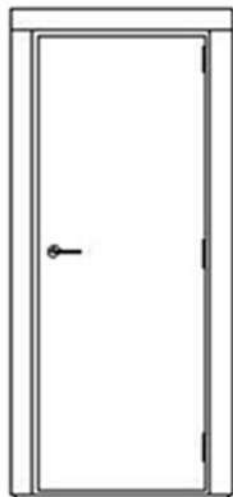
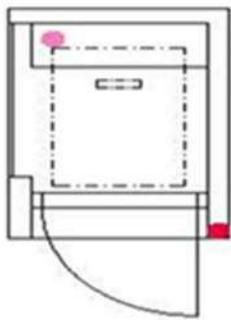

Side View



Product Comparison

	ULTRA	ZAWA	JIMMY
	Curved from top and bottom	Curved from top and bottom	No curve
Powder Coated Metal Structured			
	Powder Coated 1.2 mm Galvanised Metal Sheet	Powder Coated 1.2 mm Galvanised Metal Sheet / Fabric Finish	Powder Coated 1.2 mm Galvanised Metal Sheet/ Laminate/ Fabric Finish
Exterior Finish	100+ Colour	20+ Colour	1000+ Colour
Interior Finish			
Acoustic Pet Panels	✓	✓	✓
Foam Fabric (Low cost Model)	✗	✗	✓
Prelam Foldable Table	✓	✓	✓
Pneumatic Height Adjustable Table (At a Additional Cost)	✓	✓	✓
Glass Door			
12mm Frameless Glass Door	✓	✓	✓
Stile Door	✓	✓	✓
LED Light with occupancy sensor	✓	✓	✓
Active Ventilation	✓	✓	✓
2x Power Scocket	✓	✓	✓
USB/ Type C Charging Port	✓	✓	✓
Voice/ Data Port	✓	✓	✓
Wheel with Levelling Feet	✓	✓	✓
Glass wool insulation inside wall	✓	✓	✓
Carpet Flooring	✓	✓	✓
Cup Holder	✓	✓	✓



Single User
phone booth.
1000x1000x2100mm
1200x1200x2100mm



Single User
Work Pod
1200x1200x2100mm
1500x1500x2100mm



2 User
Meeting Pod.
1000x2100x2100mm
1200x2100x2100mm



Four or six User
Meeting Pod
1500x2100x2100mm
1800x2100x2100mm

Cutting-edge technology and advanced capabilities



Option for Height Adjustable Table



30 DB noise reduction



Automated lighting



Strong Metal Structured

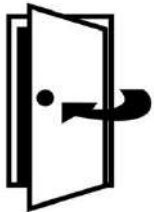

Spring Loaded Auto Close Hinges



Plug and Play for connectivity

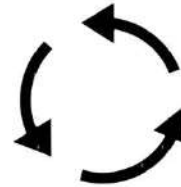

Noiseless Automated Air ventilation

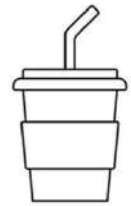

Cup Holder Inside



Glass Wool Insulated



Foldable Writing Table



Easy movement Lockable Wheels

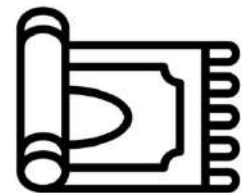

Higher End Carpeted Floor

Our Customers

Infosys



VOITH

RELIAQUEST



AMERICAN EXPRESS



FORT HILL
Associates, LLC



GAR

Verticobpo

rehlko

The Economist

Coca-Cola

Amway

Bata

TERUMO

Supreme

Syngene



param
Foundation



MTX

sidbi

Jio Star

YONEX

normet

plivo

Precot

NUCLEUS
SOFTWARE

AsteroidX

HOMELAND

NANDI
HOUSING

Hunch

INOX WIND

minfy

BHS

i-Hub
(A Gujarat Government Enterprise)

OmneNEST
Technologies

everstage

ATHER

Peace is not a luxury. Peace is a necessity.

Thank You!



C I Modular Systems Pvt. Ltd.

New Delhi : 6, F Block, Okhla Industrial Area, Phase-1, New Delhi 110020

Bangalore : 3rd Floor, Renault Palace Orchards, 210/2, Bellary Rd, Sadashiva Nagar,
Armane Nagar, Bengaluru, Karnataka 560080

info@niveetacorp.com

(P)+91 11 43015148

(M) +91 9911732329

www.niveeta.com

www.officepods.in